

2.5V Drive Nch+Pch MOSFET

EM6M1

●Structure

Silicon N-channel MOSFET /
Silicon P-channel MOSFET

●Features

- 1) Nch MOSFET and Pch MOSFET are put in EMT6 package.
- 2) High-speed switching.
- 3) Low voltage drive (2.5V drive).
- 4) Built-in G-S Protection Diode.

●Applications

Switching

●Packaging specifications

Type	Package	Taping
	Code	T2R
	Basic ordering unit (pieces)	8000
EM6M1		○

●Dimensions (Unit : mm)

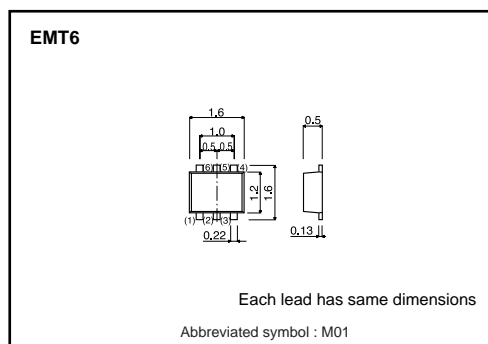

●Inner circuit

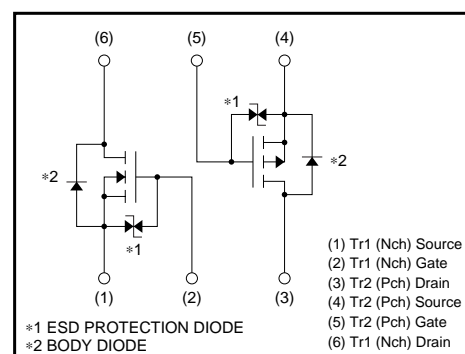

●Absolute maximum ratings (Ta=25°C)

Parameter	Symbol	Limits		Unit
		Tr1 : N-ch	Tr2 : P-ch	
Drain-source voltage	V_{DSS}	30	-20	V
Gate-source voltage	V_{GSS}	± 20	± 12	V
Drain current	Continuous	I_D	± 0.1	A
	Pulsed	I_{DP}^{*1}	± 0.4	A
Power dissipation	P_D^{*2}	150		mW / TOTAL
		120		mW / ELEMENT
Channel temperature	T_{ch}	150		°C
Range of storage temperature	T_{stg}	-55 to +150		°C

*1 $P_w \leq 10\mu s$, Duty cycle $\leq 1\%$

*2 Mounted on a ceramic board

●Notice

This product might cause chip aging and breakdown under the large electrified environment.
Please consider to design ESD protection circuit.

Transistors

N-ch

●Electrical characteristics (Ta=25°C)

Parameter	Symbol	Min.	Typ.	Max.	Unit	Conditions
Gate-source leakage	I _{GSS}	–	–	±1	μA	V _{GS} = ±20V, V _{DS} =0V
Drain-source breakdown voltage	V _{(BR) DSS}	30	–	–	V	I _D =10μA, V _{GS} =0V
Zero gate voltage drain current	I _{DSS}	–	–	1	μA	V _{DS} =30V, V _{GS} =0V
Gate threshold voltage	V _{GS(th)}	0.8	–	1.5	V	V _{DS} =3V, I _D =100μA
Static drain-source on-state resistance	R _{DS(on)} *	–	5	8	Ω	I _D =10mA, V _{GS} =4V
		–	7	13	Ω	I _D =1mA, V _{GS} =2.5V
Forward transfer admittance	Y _{fs} *	20	–	–	mS	V _{DS} =3V, I _D =10mA
Input capacitance	C _{iss}	–	13	–	pF	V _{DS} =5V
Output capacitance	C _{oss}	–	9	–	pF	V _{GS} =0V
Reverse transfer capacitance	C _{rss}	–	4	–	pF	f=1MHz
Turn-on delay time	t _{d(on)} *	–	15	–	ns	V _{DD} ≐5V
Rise time	t _r *	–	35	–	ns	I _D =10mA
Turn-off delay time	t _{d(off)} *	–	80	–	ns	V _{GS} =5V
Fall time	t _f *	–	80	–	ns	R _L =500Ω
Total gate charge	Q _g *	–	0.9	–	nC	V _{DD} ≐15V, I _D =0.1A
Gate-source charge	Q _{gs} *	–	0.2	–	nC	V _{GS} =4.5V
Gate-drain charge	Q _{gd} *	–	0.2	–	nC	R _L =150Ω, R _G =10Ω

*Pulsed

P-ch

●Electrical characteristics (Ta=25°C)

Parameter	Symbol	Min.	Typ.	Max.	Unit	Conditions
Gate-source leakage	I _{GSS}	–	–	±10	μA	V _{GS} = ±12V, V _{DS} =0V
Drain-source breakdown voltage	V _{(BR) DSS}	–20	–	–	V	I _D = –1mA, V _{GS} =0V
Zero gate voltage drain current	I _{DSS}	–	–	–1	μA	V _{DS} = –20V, V _{GS} =0V
Gate threshold voltage	V _{GS(th)}	–0.7	–	–2.0	V	V _{DS} = –10V, I _D = –1mA
Static drain-source on-state resistance	R _{DS(on)} *	–	1.0	1.5	Ω	I _D = –0.2A, V _{GS} = –4.5V
		–	1.1	1.6	Ω	I _D = –0.2A, V _{GS} = –4V
		–	2.0	3.0	Ω	I _D = –0.2A, V _{GS} = –2.5V
Forward transfer admittance	Y _{fs} *	0.2	–	–	S	V _{DS} = –10V, I _D = –0.15A
Input capacitance	C _{iss}	–	50	–	pF	V _{DS} = –10V
Output capacitance	C _{oss}	–	5	–	pF	V _{GS} = 0V
Reverse transfer capacitance	C _{rss}	–	5	–	pF	f=1MHz
Turn-on delay time	t _{d(on)} *	–	9	–	ns	V _{DD} ≐ –15V
Rise time	t _r *	–	6	–	ns	I _D = –0.15A
Turn-off delay time	t _{d(off)} *	–	35	–	ns	V _{GS} = –4.5V
Fall time	t _f *	–	45	–	ns	R _L = 100Ω
Total gate charge	Q _g *	–	1.2	–	nC	V _{DD} ≐ –15V, I _D = –0.2A
Gate-source charge	Q _{gs} *	–	0.2	–	nC	V _{GS} = –4.5V
Gate-drain charge	Q _{gd} *	–	0.2	–	nC	R _L = 75Ω, R _G = 10Ω

*Pulsed

Transistors

N-ch

●Electrical characteristic curve

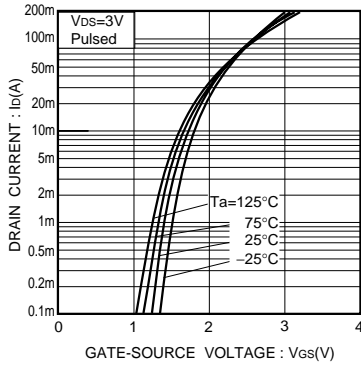

Fig.1 Typical Transfer Characteristics

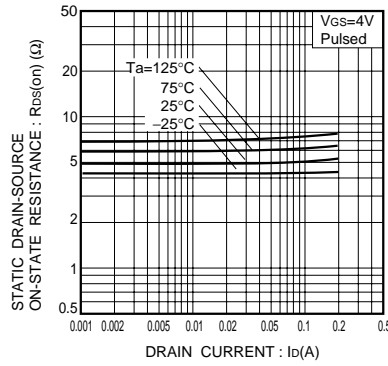

Fig.2 Static Drain-Source On-State Resistance vs. Drain Current (I)

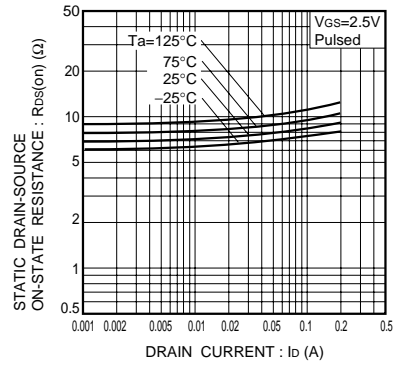

Fig.3 Static Drain-Source On-State Resistance vs. Drain Current (II)

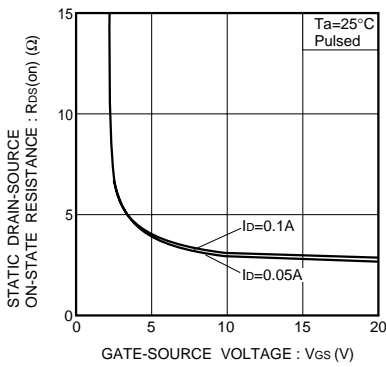

Fig.4 Static Drain-Source On-State Resistance vs. Gate-Source Voltage

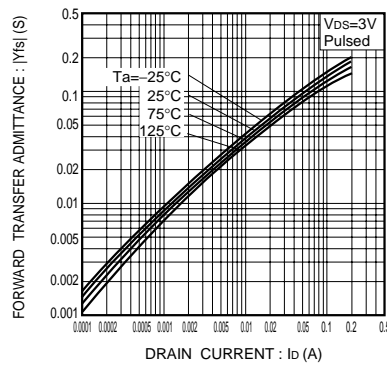

Fig.5 Forward Transfer Admittance vs. Drain Current

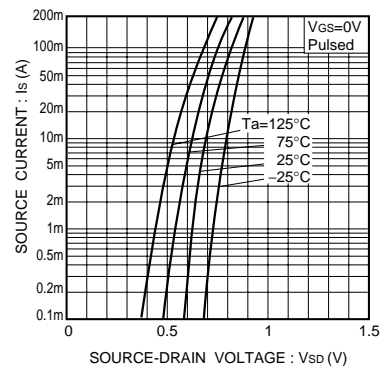

Fig.6 Reverse Drain Current vs. Source-Drain Voltage (I)

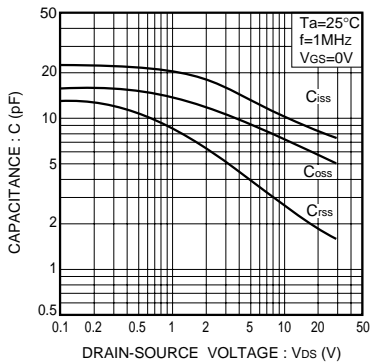

Fig.7 Typical Capacitance vs. Drain-Source Voltage

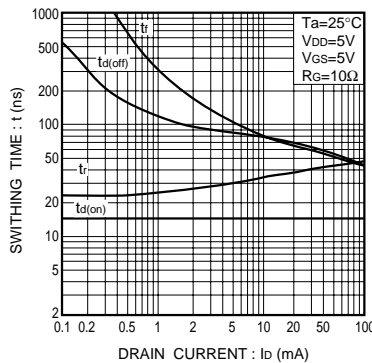

Fig.8 Switching Characteristics

Transistors

P-ch

●Electrical characteristic curve

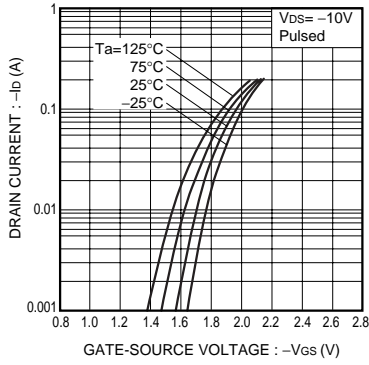

Fig.1 Typical Transfer Characteristics

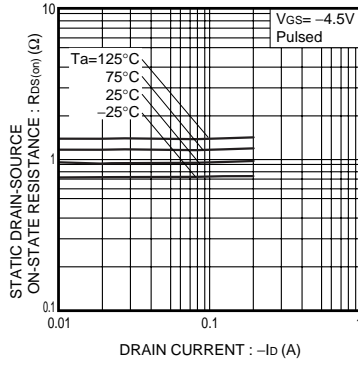

Fig.2 Static Drain-Source On-State Resistance vs. Drain Current (I)

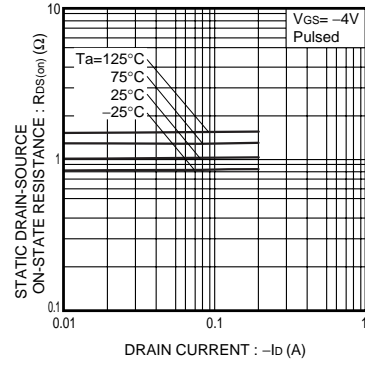

Fig.3 Static Drain-Source On-State Resistance vs. Drain Current (II)

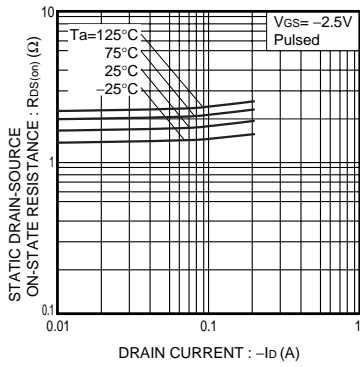

Fig.4 Static Drain-Source On-State Resistance vs. Drain Current (III)

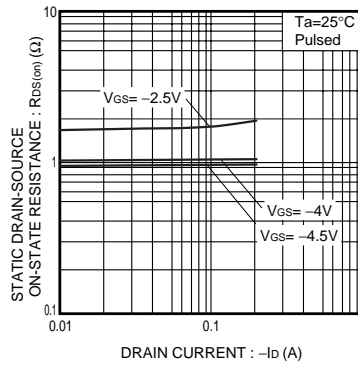

Fig.5 Static Drain-Source On-State Resistance vs. Drain Current (IV)

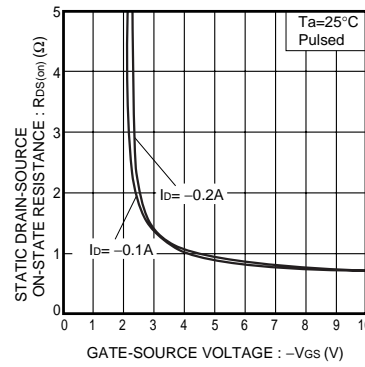

Fig.6 Static Drain-Source On-State Resistance vs. Gate-Source Voltage

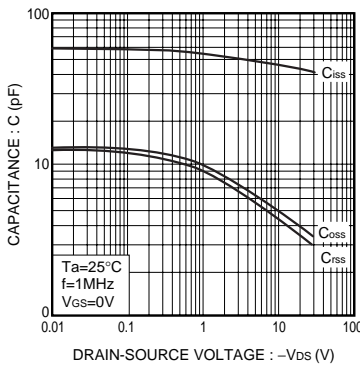

Fig.7 Typical Capacitance vs. Drain-Source Voltage

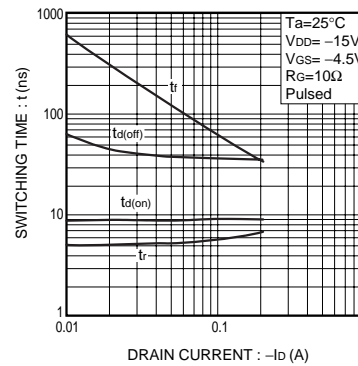

Fig.8 Switching Characteristics

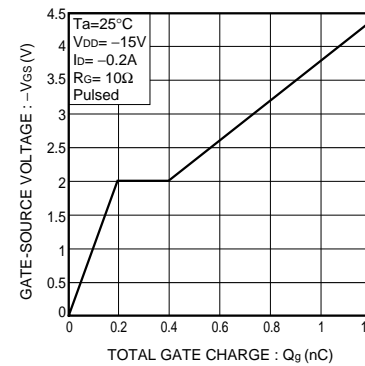

Fig.9 Dynamic Input Characteristics

Transistors

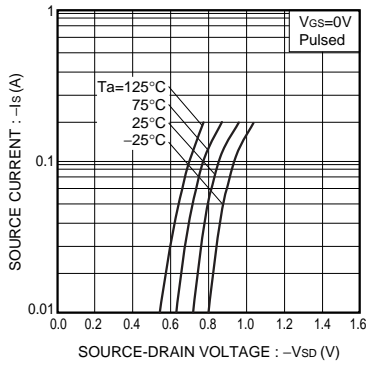

Fig.10 Source Current vs. Source-Drain Voltage

N-ch

●Measurement circuit

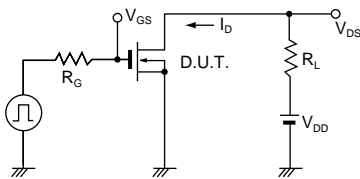

Fig.9 Switching Time Test Circuit

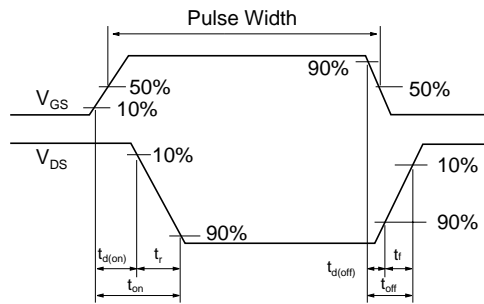

Fig.10 Switching Time Waveforms

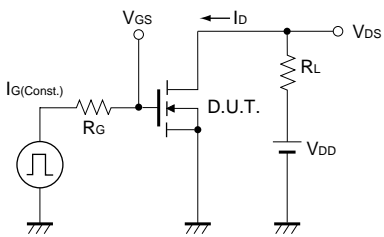

Fig.11 Gate Charge Measurement Circuit

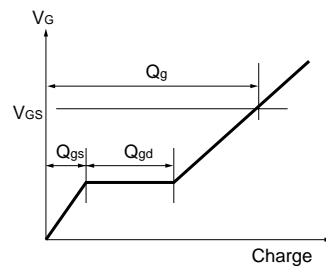

Fig.12 Gate Charge Waveform

Transistors

P-ch

●Measurement circuit

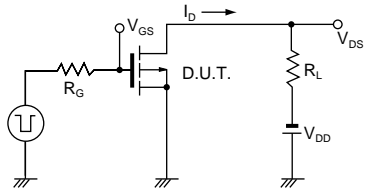

Fig.11 Switching Time Test Circuit

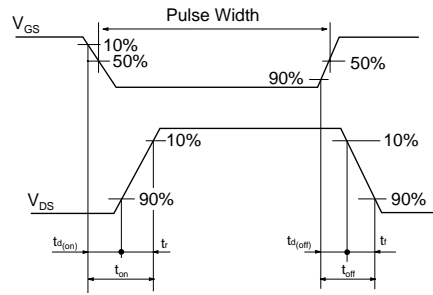

Fig.12 Switching Time Waveforms

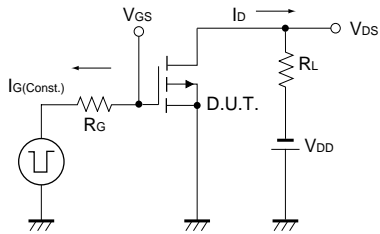

Fig.13 Gate Charge Measurement Circuit

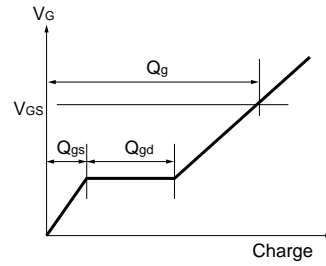

Fig.14 Gate Charge Waveform

Notes

- No technical content pages of this document may be reproduced in any form or transmitted by any means without prior permission of ROHM CO.,LTD.
- The contents described herein are subject to change without notice. The specifications for the product described in this document are for reference only. Upon actual use, therefore, please request that specifications to be separately delivered.
- Application circuit diagrams and circuit constants contained herein are shown as examples of standard use and operation. Please pay careful attention to the peripheral conditions when designing circuits and deciding upon circuit constants in the set.
- Any data, including, but not limited to application circuit diagrams information, described herein are intended only as illustrations of such devices and not as the specifications for such devices. ROHM CO.,LTD. disclaims any warranty that any use of such devices shall be free from infringement of any third party's intellectual property rights or other proprietary rights, and further, assumes no liability of whatsoever nature in the event of any such infringement, or arising from or connected with or related to the use of such devices.
- Upon the sale of any such devices, other than for buyer's right to use such devices itself, resell or otherwise dispose of the same, no express or implied right or license to practice or commercially exploit any intellectual property rights or other proprietary rights owned or controlled by
- ROHM CO., LTD. is granted to any such buyer.
- Products listed in this document are no antiradiation design.

The products listed in this document are designed to be used with ordinary electronic equipment or devices (such as audio visual equipment, office-automation equipment, communications devices, electrical appliances and electronic toys).

Should you intend to use these products with equipment or devices which require an extremely high level of reliability and the malfunction of which would directly endanger human life (such as medical instruments, transportation equipment, aerospace machinery, nuclear-reactor controllers, fuel controllers and other safety devices), please be sure to consult with our sales representative in advance.

It is our top priority to supply products with the utmost quality and reliability. However, there is always a chance of failure due to unexpected factors. Therefore, please take into account the derating characteristics and allow for sufficient safety features, such as extra margin, anti-flammability, and fail-safe measures when designing in order to prevent possible accidents that may result in bodily harm or fire caused by component failure. ROHM cannot be held responsible for any damages arising from the use of the products under conditions out of the range of the specifications or due to non-compliance with the NOTES specified in this catalog.

Thank you for your accessing to ROHM product informations.

More detail product informations and catalogs are available, please contact your nearest sales office.

ROHM Customer Support System

THE AMERICAS / EUROPE / ASIA / JAPAN

www.rohm.com

Contact us : webmaster@rohm.co.jp